

CONTROL COMPONENTS

HICF Axial Fan

Standard: EN 55032:2015; EN61000-3-2:2014; EN61000-3-3:2013;



Range Presentation:

HICF series axial fan is designed for cooling and air ventilation for control panels, cabinets, machines, electric appliance, EV cars, etc.
The products meet the requirements of 24h continuous working condition.

Features:

- ◆ With good quality and high strength shell, the HICF series axial fan is temperature, break and corrosion resistant.
- ◆ Equipped with high quality motor, the axial fan has large air volume, low noise and good heat dissipation effect.
- ◆ High quality copper coil, good conductivity, low power consumption, low heating.
- ◆ Anti-reverse wire connection protection - safer to use.

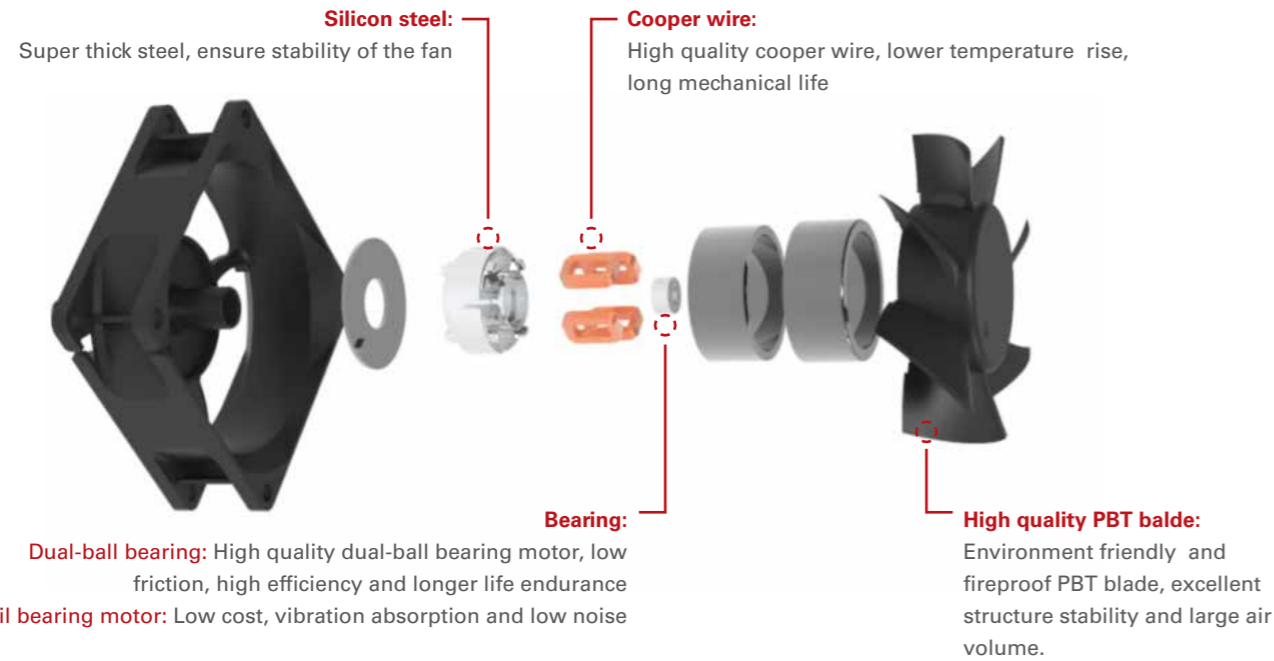

Selection Code

Range name	Width	Height	Voltage	Bearing	Connection
HICF	280	80	A2	B	L
HICF	40: 40x40mm 50: 50x50mm 80: 80x80mm 92: 92x92mm 120: 120x120mm 160: 160x160mm 180: 180x180mm 200: 200x200mm ... Special: 170: 172x150mm	15: 15mm 20: 20mm 25: 25mm 38: 38mm 50: 50mm 60: 60mm 70: 70mm	A2: AC220V D2: DC24V D1: DC12V ...	B: ball S: lube	L: cable-out

CONTROL COMPONENTS

HICF Axial Fan

Standard: EN 55032:2015; EN61000-3-2:2014; EN61000-3-3:2013;

Technical Parameter

AC axial Fan

Frame is made of Aluminum Alloy material, Impeller is made of :PBT+30%GF material; Insulation level:CLASS B; protection level: IP44.



Commercial reference	HICF8025A2BL	HICF8025A2SL	HICF8038A2BL	HICF8038A2SL
Product size (mm)	80*80*25	80*80*25	80*80*38	80*80*38
Rated voltage	220V AC at 50/60 Hz	220V AC at 50/60 Hz	220V AC at 50/60 Hz	220V AC at 50/60 Hz
Rated current (A)	0.09/0.08A	0.09/0.08A	0.06/0.05A	0.06/0.05A
Rated power(W)	15/12W	15/12W	9.5/7W	9.5/7W
Speed (RPM)	2300/2750	2300/2750	2550/3100	2550/3100
Air pressure mmH ₂ O (mmAQ)	2.2/2.4	2.2/2.4	2.6/2.8	2.6/2.8
Noise level (dBA)	38	38	38	38
Air flow (CFM)	32/35	32/35	39/42	39/42



Commercial reference	HICF9225A2BL	HICF9225A2SL	HICF9238A2SL	HICF12025A2BL
Product size (mm)	92*92*25	92*92*25	92*92*38	120*120*25
Rated voltage	220V AC at 50/60 Hz	220V AC at 50/60 Hz	220V AC at 50/60 Hz	220V AC at 50/60 Hz
Rated current (A)	0.1/0.08A	0.1/0.08A	0.06/0.05A	0.1/0.08A
Rated power(W)	13/11W	16/13W	10/8W	17/14W
Speed (RPM)	2350/2800	2350/2800	2300/2750	2300/2700
Air pressure mmH ₂ O (mmAQ)	3.1/3.4	3.1/3.4	4.5/4.9	2.9/3.1
Noise level (dBA)	38	38	41	45
Air flow (CFM)	45/50	45/50	66/72	44/45



Commercial reference	HICF12025A2SL	HICF12038A2BL	HICF12038A2SL	HICF15050A2BL
Product size (mm)	120*120*25	120*120*38	120*120*38	150*150*50
Rated voltage	220V AC at 50/60 Hz	220V AC at 50/60 Hz	220V AC at 50/60 Hz	220V AC at 50/60 Hz
Rated current (A)	0.1/0.08A	0.15/0.12A	0.15/0.12A	0.25/0.23A
Rated power(W)	17/14W	21/18W	21/18W	35/32W
Speed (RPM)	2300/2700	2600/3000	2600/3000	2600/2900
Air pressure mmH ₂ O (mmAQ)	2.9/3.1	6.7/7.6	6.7/7.6	16/17.8
Noise level (dBA)	45	48	48	51
Air flow (CFM)	44/45	93/98	93/98	372/400

CONTROL COMPONENTS

HICF Axial Fan

Standard: EN 55032:2015; EN61000-3-2:2014; EN61000-3-3:2013;



Commercial reference	HICF16060A2BL	HICF17040A2BL	HICF17050A2BL	HICF20060A2BL	HICF20070A2BL
Product size (mm)	160*160*60	172*150*38	172*150*51	200*200*60	200*200*70
Rated voltage	220V AC at 50/60 Hz	220V AC at 50/60 Hz	220V AC at 50/60 Hz	220V AC at 50/60 Hz	220V AC at 50/60 Hz
Rated current (A)	0.13/0.1A	0.14/0.13A	0.25/0.23A	0.48/0.5A	0.2/0.22A
Rated power(W)	25/24W	28/27W	35/32W	68/75W	45/52W
Speed (RPM)	2750/3150	2850/3300	2600/2900	2600/3000	2550/2950
Air pressure mmH ₂ O (mmAQ)	26.5/28.6	10.2/11.6	17/18.8	25/33	32
Noise level (dBA)	61	51	51	67	68
Air flow (CFM)	390/420	150/170	206/251	370/420	465

DC Axial Fan

Made of PBT+30%GF material; Insulation level:CLASS B; protection level: IP44.



Commercial reference	HICF4020D2SL	HICF5015D2BL	HICF5020D2BL	HICF6025D2BL	HICF8025D2BL
Product size (mm)	40*40*20	50*50*15	50*50*20	60*60*25	80*80*25
Rated voltage	24V DC	24V DC	24V DC	24V DC	24V DC
Rated current (A)	0.05A	0.1A	0.12A	0.12A	0.25A
Rated power(W)	0.72W	2.4W	2.4W	4.8W	2.64W
Speed (RPM)	5800RPM	6400RPM	5800RPM	5500RPM	3500RPM
Air pressure mmH ₂ O (mmAQ)	3.9	5.23	6.55	8.1	4.94
Noise level (dBA)	27	36.7	35.08	37.8	37.9
Air flow (CFM)	6.6	14.5	21.71	23.8	43.9





Commercial reference	HICF9225D2BL	HICF9225D2SL	HICF12025D2BL	HICF12025D1BL	HICF12038D1BL	HICF12038D2BL
Product size (mm)	92*92*25	92*92*25	120*120*25	120*120*25	120*120*38	120*120*38
Rated voltage	24V DC	24V DC	24V DC	12V DC	12V DC	24V DC
Rated current (A)	0.38A	0.26A	0.25A	0.25A	0.3A	0.2A
Rated power(W)	7.2W	7.2W	6.72W	7.2W	4.8W	4.8W
Speed (RPM)	4000RPM	4000RPM	2600RPM	2600RPM	2600RPM	2500RPM
Air pressure mmH ₂ O (mmAQ)	6	6	5.3	5.3	6.24	6.24
Noise level (dBA)	41.2	41.2	37.2	37.2	42.6	42.6
Air flow (CFM)	64.8	64.8	78.2	78.2	117.6	117.6

CONTROL COMPONENTS

HICF Axial Fan

Standard: EN 55032:2015; EN61000-3-2:2014; EN61000-3-3:2013;

Accessories

Picture	Commercial reference	Description	Size
 Metal protection net	HICFG80	Metal protection net, Suitable for 80mm fan	80MM
	HICFG90	Metal protection net, Suitable for 92mm fan	90MM
	HICFG110	Metal protection net, Suitable for 110mm fan	110MM
	HICFG120	Metal protection net, Suitable for 120mm fan	120MM
	HICFG150	Metal protection net, Suitable for 150-160mmfan	150MM
	HICFG200	Metal protection net, Suitable for 200-210mm fan	200MM
 Filter net	HICFF80	Filter net, Suitable for 80mm fan	80MM
	HICFF92	Filter net, Suitable for 90mm fan	90MM
	HICFF120	Filter net, Suitable for 120mm fan	120MM
	HICFF170	Filter net, Suitable for 170x50 150x50mm fan	150MM
 Three in one dustproof net	HICFD80	Three in one dustproof net for 80mm fan	80MM
	HICFD90	Three in one dustproof net for 92mm fan	90MM
	HICFD120	Three in one dustproof net for 120mm fan	120MM
	HICFD150	Three in one dustproof net for 160mm fan	150MM
	HICFD200	Three in one dustproof net for 210mm fan	200-210mm

Installation Dimension Drawing

AC Axial Fan

8025A

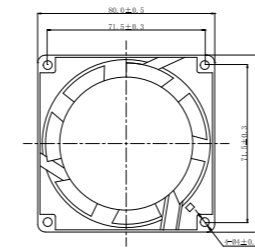

8038A

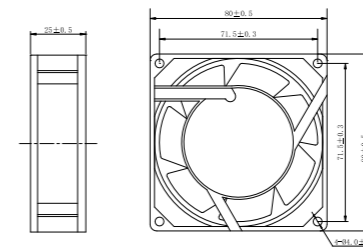

9225A

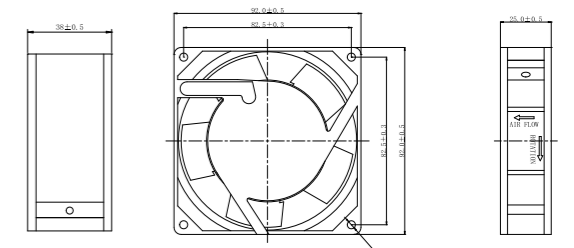

11025A

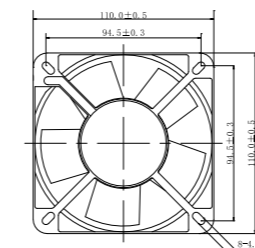

12025A

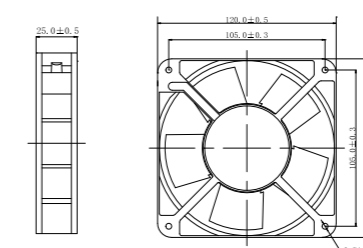

12038A

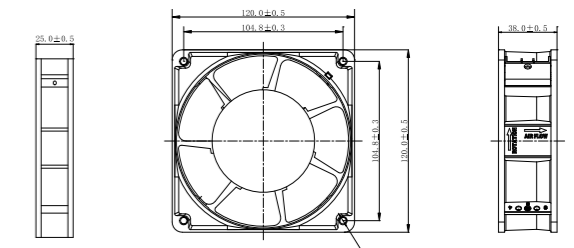

CONTROL COMPONENTS

HICF Axial Fan

Standard: EN 55032:2015; EN61000-3-2:2014; EN61000-3-3:2013;

****15050A****

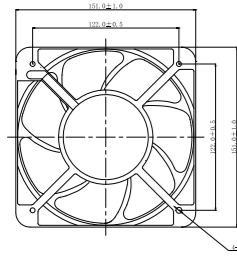

****20060A****

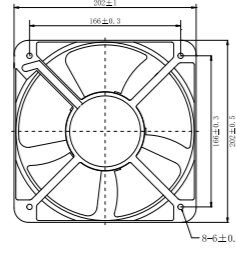

DC Axial Fan

****4020D****

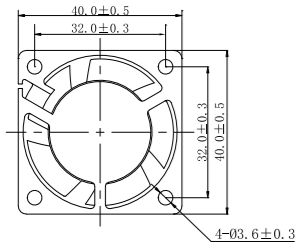

****5015D****

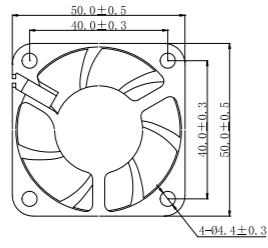

****5020D****

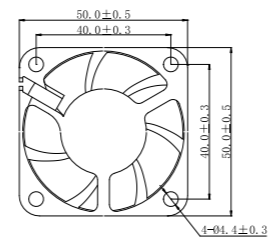

****6025D****

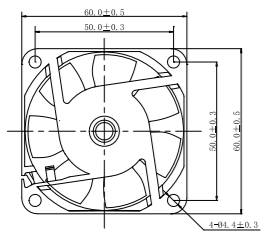

****8025D****

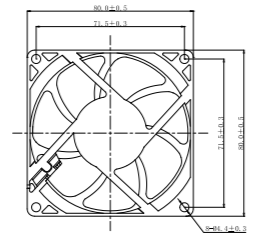

****8038D****

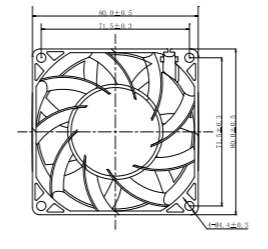

****9225D****

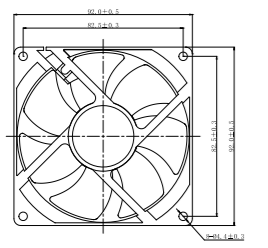

****12025D****

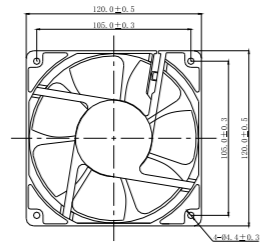

****12038D****

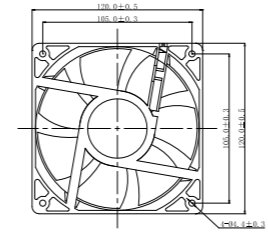

Installation Dimension Drawing

HICFF80

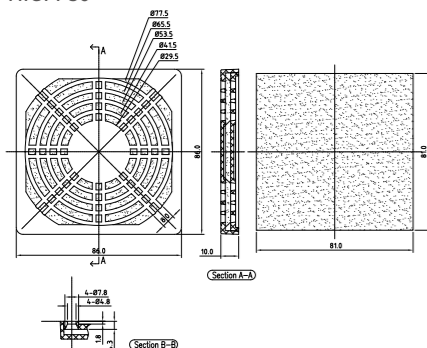

HICFF90

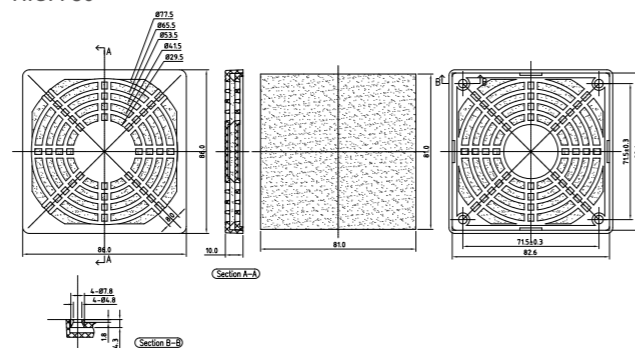

CONTROL COMPONENTS

HICF Axial Fan

Standard: EN 55032:2015; EN61000-3-2:2014; EN61000-3-3:2013;

HICFF120

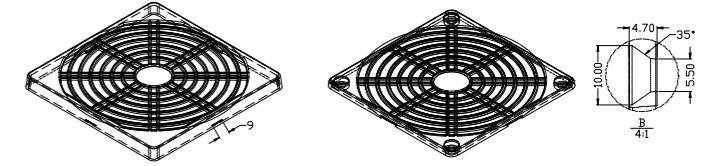
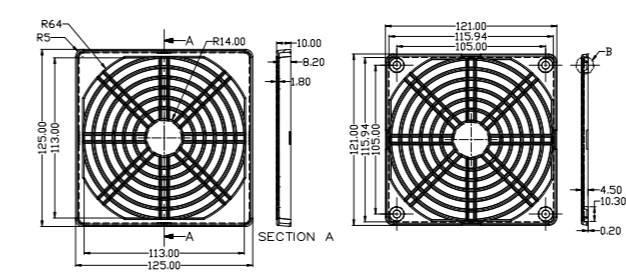

HICFF150

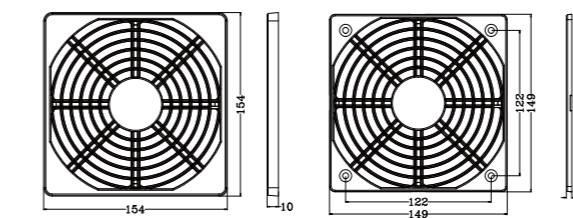

HICFD120

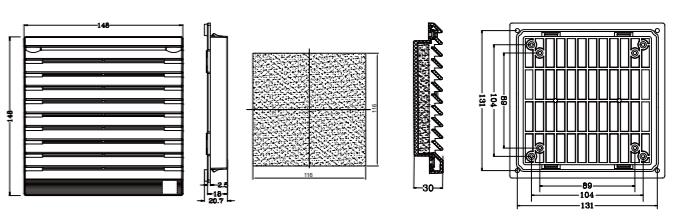

HICFD80

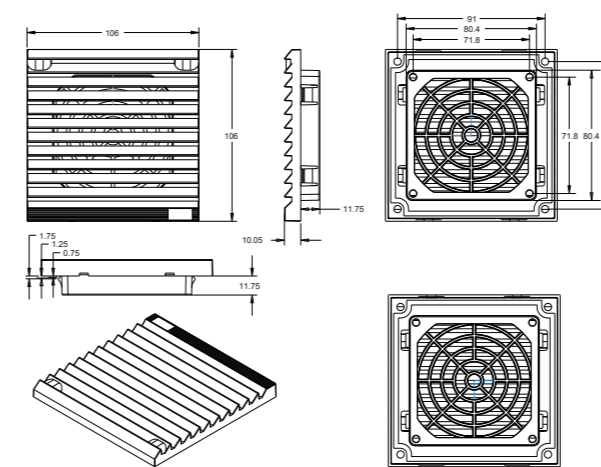

HICFD92

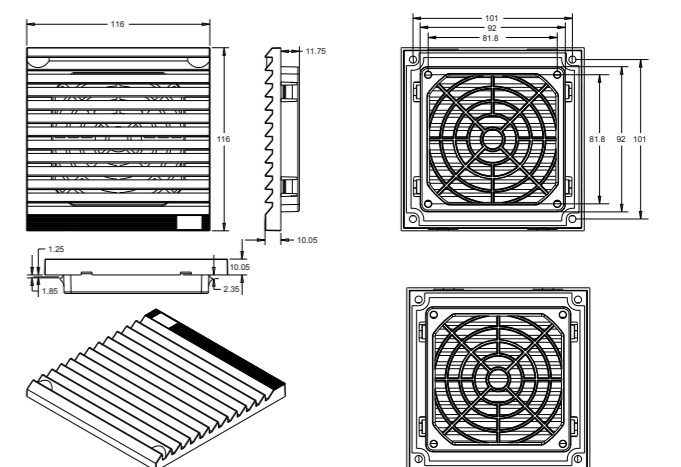

HICFD150

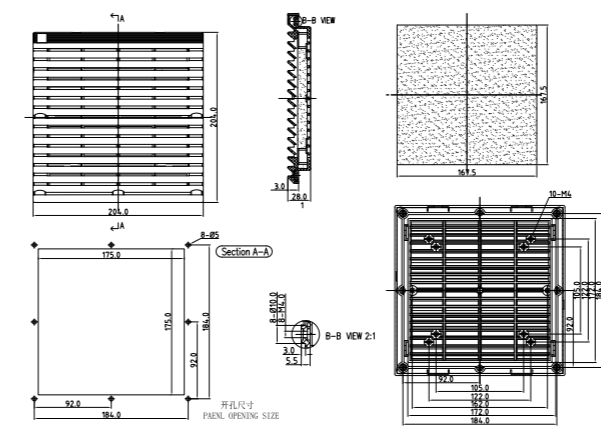

HICFD200

